

BOMBAS HIDRÁULICAS DELCON

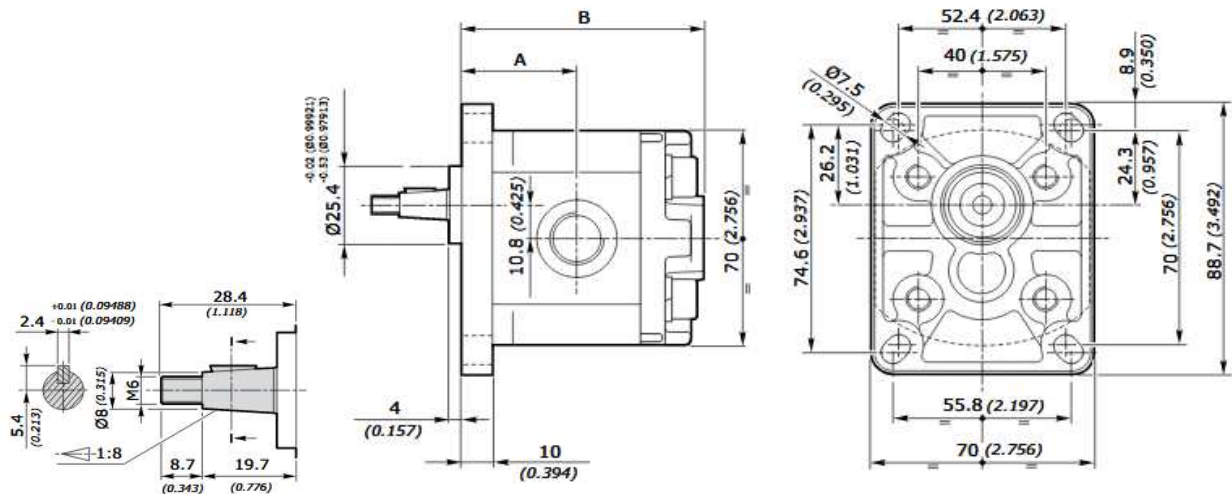

BOMBAS DE ENGRANAJES -DELCON- GR1

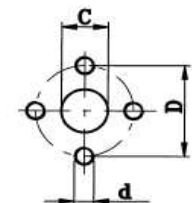
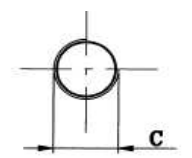

REFERENCIA	Cm ³ /rev	Lts a 1500 RPM	BAR max (trabajo)	Dimensiones		PVP	
				D IN	D OUT		
BHP1BO-D4,8TOE0	4,8	7	200	30	30		
BHP1BO-D5,8TOE1	5,8	9	200	30	30		
				C (ROSCA)			
AFCCBD1F22,1G	2,1	3	200	3/8	3/8		
AFCCBD1F22,7G	2,7	4	200	3/8	3/8		
AFCCBD1F23,2G	3,2	4,8	200	3/8	3/8		
AFCCBD1F24,2G	4,2	6	200	3/8	3/8		
AFCCBD1F24,8G	4,8	7	200	3/8	3/8		
AFCCBD1F25,8G	5,8	9	200	3/8	3/8		
B-AFC-GR1				KIT JUNTAS PARA GR1 (R10X19X7)			

BOMBAS DE ENGRANAJES -DELCON- GR2

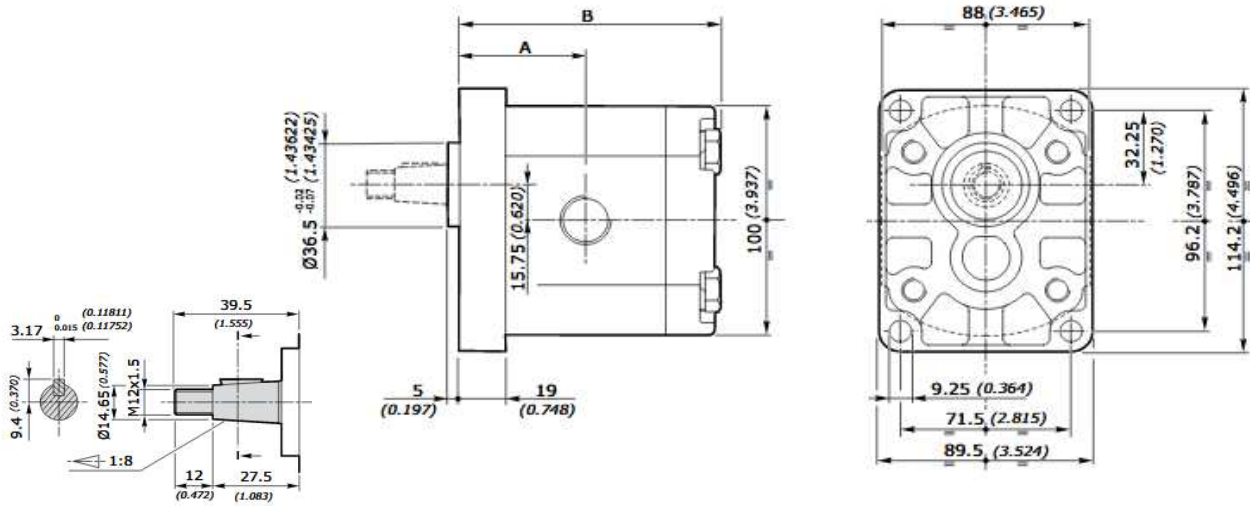

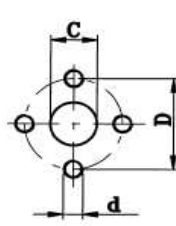
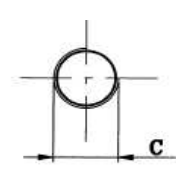
REFERENCIA	Cm3/rev	Lts a 1500 RPM	BAR max (Trabajo)	Dimensiones		PVP	
				D IN	D OUT		
BHP2B0-D4TOE0	4	6	200	30	30		
BHP2B0-D8TOE0	8	12	200	30	30		
BHP2B0-D10TOE1	10	15	200	40	30		
BHP2B0-D12TOE1	12	18	200	40	30		
BHP2B0-D14TOE1	14	21	200	40	30		
BHP2B0-D16TOE1	16	24	200	40	30		
BHP2B0-D20TOE1	20	30	200	40	30		
BHP2B0-D25TOE2	25	38	200	40	30		
				C (ROSCA)			
BHP2B0-D4TOL0	4	6	200	1/2	1/2		
BHP2B0-D6TOL0	6	9	200	1/2	1/2		
BHP2B0-D8TOL1	8	12	200	3/4	1/2		
BHP2B0-D10TOL1	10	15	200	3/4	1/2		
BHP2B0-D14TOL1	14	21	200	3/4	1/2		
BHP2B0-D16TOL1	16	24	200	3/4	1/2		
BHP2B0-D20TOL1	20	30	200	3/4	1/2		
BHP2B0-D25TOL1	25	38	200	3/4	1/2		
B-AFC-GR2	KIT JUNTAS PARA GR2 (R18X30X7)						

BOMBAS PARA MAQUINARIA AGRÍCOLA Y OBRA PÚBLICA



BOMBAS DE ENGRANAJES -DELCON- GR3

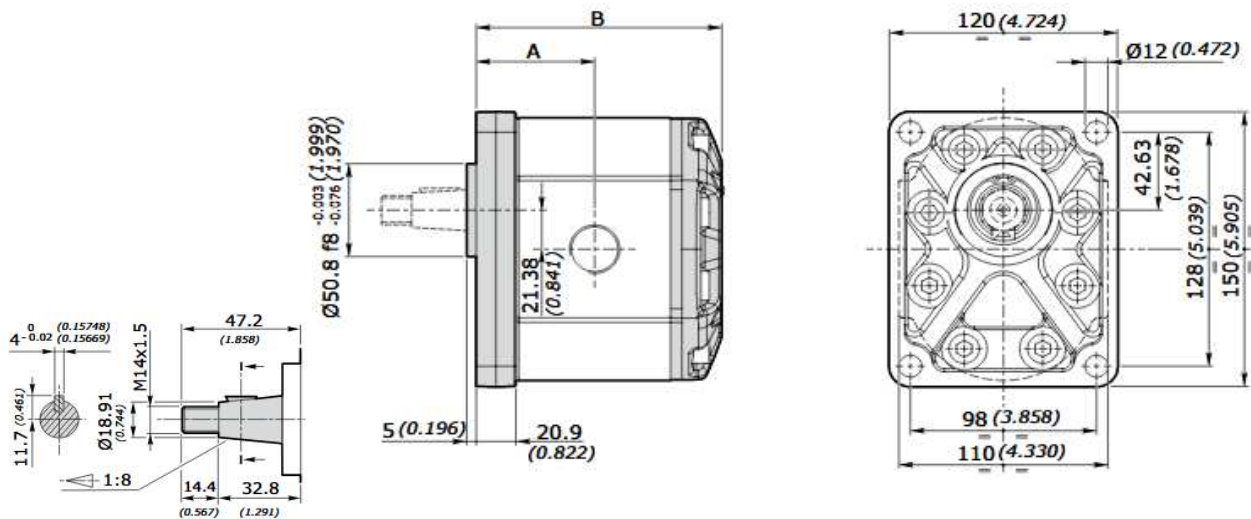

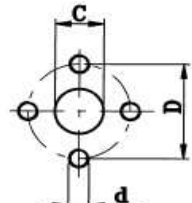
REFERENCIA	Cm3/rev	Lts a 1500 RPM	BAR max (trabajo)	Dimensiones		PVP	
				D IN	d OUT		
BHP3B1-D22T0E0	22	33	200	51	40		
BHP3B1-D26T0E0	26	39	200	51	40		
BHP3B1-D33T0E0	33	50	200	51	40		
BHP3B1-D39T0E0	39	58	200	51	40		
BHP3B1-D46T0E0	46	69	200	51	40		
BHP3B1-D50T0E0	50	75	200	51	40		
BHP3B1-D63T0E0	63	95	200	56	51		
B-AFC-GR3	KIT JUNTAS PARA GR3 (R25X42X10)						

BOMBAS DE ENGRANAJES -DELCON- PARA MINICENTRAL

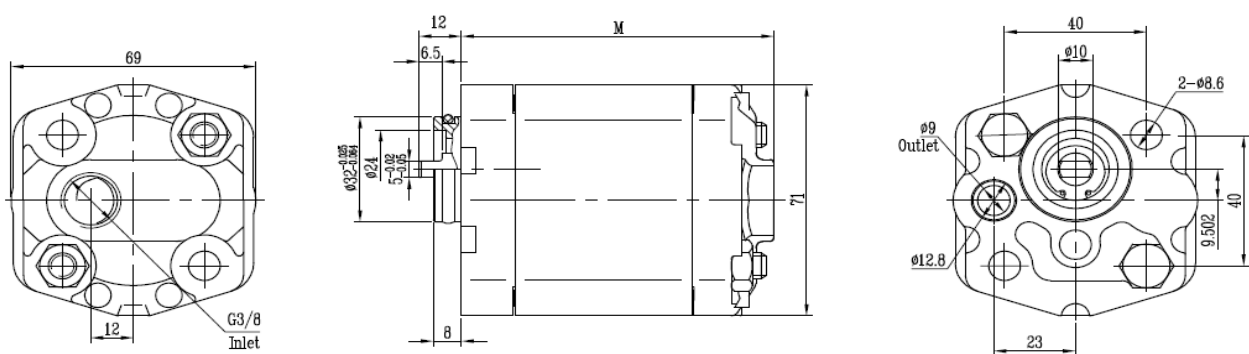

REFERENCIA	Cm3/rev	Lts a 1500 RPM	BAR max (trabajo)	SENTIDO GIRO	PVP	
BKP1Q0S2.1G0L1B	2,1		200	IZQUIERDA		
BKP1Q0S2.7G0L1B	2,7		200	IZQUIERDA		
BKP1Q0S3.2G0L1B	3,2		200	IZQUIERDA		
BKP1Q0S5.8G0L1B	5,8		200	IZQUIERDA		
BKP1Q0S8.0G0L1B	8		200	IZQUIERDA		
B-BKP1	KIT JUNTAS PARA BKP1... (R10X19X7)					

BOMBAS DE ENGRANAJES TANDEM -DELCON-

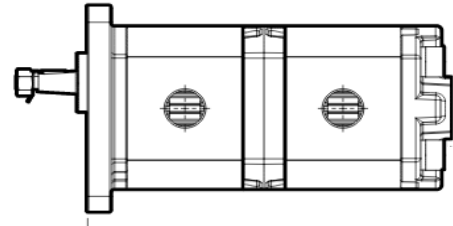

REFERENCIA	Cm3/rev	Lts a 1500	BAR max (trabajo)	GRUPO	PVP	
BHP1D5-BHP1D2	5+2,1	7+3,2	200	GR1+GR1		
BHP2/2B0-D8/8	8+8	12+12	200	GR2+GR2		
BHP2/2B0-D10/10	10+10	15+15	200	GR2+GR2		
BHP2/2B0-D14/14	14+14	21+21	200	GR2+GR2		
BHP2D16-BHP1D2	16+2,1	24+3	200	GR2+GR1		
BHP2/2B0-D16/16	16+16	24+24	200	GR2+GR2		
BHP2/2B0-D20/10	20+10	30+15	200	GR2+GR2		
BHP2/2B0-D20/20	20+20	30+30	200	GR2+GR2		
BHP2/2B0-D22/22	22+22	33+33	200	GR2+GR2		
BHP2/2B0-D25/6	25+6	37+9	200	GR2+GR2		
BHP2/2B0-D25/12	25+12	37+18	200	GR2+GR2		
BHP2/2B0-D25/16	25+16	37+24	200	GR2+GR2		
BHP2/2B0-D25/25	25+25	38+38	200	GR2+GR2		
BHP3D33-BHP2D10	33+10	50+15	200	GR3+GR2		
BHP3D33-BHP2D12	33+12	50+18	200	GR3+GR2		
BHP3D39-BHP2D12	39+12	59+18	200	GR3+GR2		
BHP3D46-BHP2D10	46+10	69+15	200	GR3+GR2		
BHP3D46-BHP2D12	46+12	69+18	200	GR3+GR2		
BHP3D52-BHP2D14	52+14	78+21	200	GR3+GR2		

BOMBAS HIDRÁULICAS de PISTONES - TIPO VOLVO



REFERENCIA	Cm3/rev		BAR max	DIN ESTANDAR	PVP	
B-BI30M	32		350	DIN5462		
B-BI40M	42		350	DIN5462		
B-BI50M	50		350	DIN5462		
B-BI60M7	60		350	DIN5462		
B-BI80M7	80		300	DIN5462		
B-BI110P7	108		350	DIN5462		

PLATO SAE 1300 - EXT.97mm (DIN5462)



REFERENCIA					PVP	
B-900515						

MOTORES HIDRÁULICOS GR3 - CASAPPA- KM30

Cuerpo fundición
Drenaje lateral

Especial desbrozadoras



REFERENCIA	Cm3/rev		BAR max	rpm Max.	PVP	
BOM-KM30,27LO	27		280	3000		
BOM-KM30,34LO	34		260	3000		
BOM-KM30,38LO	38		260	3000		
BOM-KM30,43LO	43		250	3000		